	PRODUCT SPECIFICATION C2xFMW3 24W			Page 1/18
	Document prepared and responsible for			
	M. Mauritz			
	Responsible for technical data	Day	Month	Year
S. Trethan	28	03	22	M

EGSTON

Switch Mode Battery Charger for Li-ion/NiMH/NiCd cells

Product Name: C2xFMW3 24W

Input:	90 - 264 VAC
Output :	3,0 V – 25,5 V DC max. 24 W max. 2,5 A
Type:	C2xFMW3 24W

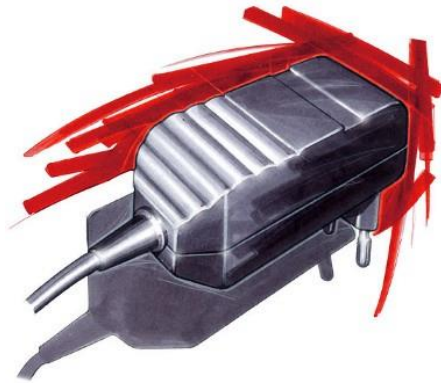

CONFIDENTIAL

This document contains proprietary information originated and/or owned by EGSTON GmbH. This information shall not be duplicated, used or disclosed in whole, or in part, to any other party or used for any other purpose without the prior consent of EGSTON GmbH.

Copyright © 2022 EGSTON GmbH.
A-3730 Eggenburg, Grafenberger Strasse 37
All Rights Reserved.

	PRODUCT SPECIFICATION C2xFMW3 24W			Page 2/18
	Document prepared and responsible for			
	M. Mauritz			
	Responsible for technical data	Day	Month	Year
S. Trethan	28	03	22	M

1 REVISION HISTORY

1.1 Evolution

Edition	Date	Responsible	Reason of change
B	17.09.2004	Dolanský	preliminary
C	28.10.2004	Dolanský	
D	14.04.2006	Lambeck	
E	14.12.2006	Lambeck	
F	17.04.2007	Lambeck	Sign off
G	20.02.2008	Obritzhauser	Changeable plug housing implemented
H	20.01.2009	Mauritz	C2xFxW changed to C2xFzW3
I	15.04.2013	Mauritz	Signaling changed
J	24.04.2019	Mauritz	Housing Material: 6W removed; Ordering information changed; Standards and Approvals changed
K	01.08.2019	Mauritz	Nominal output cable length changed; Medical EMC added; Surge changed
L	26.11.2020	Mauritz	Household and Information Technology removed
M	28.03.2022	Mauritz	UKCA mark added, Standards changed

1.2 Sign off

NAME

COMPANY

DATE

Signoff indicated that the design and function of the charger are approved. Egston is responsible for maintaining the construction of the charger so that it continues to comply with regulatory agency requirements.

	PRODUCT SPECIFICATION C2xFMW3 24W			Page 3/18
	Document prepared and responsible for			
	M. Mauritz			
	Responsible for technical data	Day	Month	Year
S. Trethan	28	03	22	M

2 SCOPE

This document describes a switch mode power supply unit (AC/DC converter) with a sub board for charging Li-ion/NiMH/NiCd batteries.

The unit is designed as a Wall Plug In power supply or a Desk Top Module.

According to the standard: Medical.

	PRODUCT SPECIFICATION C2xFMW3 24W			Page 4/18	
	Document prepared and responsible for				
	M. Mauritz				
	Responsible for technical data	Day	Month	Year	Revision
S. Trethan	28	03	22	M	

3 TECHNICAL SPECIFICATION SHEET

3.1 Input Specification

Parameter	Key	Min	Typ.	Max	Unit	Test Cond.
Input Voltage	U_{IN}	90		264	V	AC
Input Current	I_{IN}	9		620	mA	
Input Frequency	f_{IN}	47		63	Hz	
Efficiency	η	73		83	%	At full load
Switching Frequency	f_{sw}		40		kHz	
Stand-by power	P_{stb}		850		mW	Without load

Input Voltage

If the input voltage is outside the operating range, the power supply does not meet the full specification. Above the specified upper limit of the input voltage the unit can get damaged. Below the specified lower limit of the input voltage the unit does not meet the specification.

Efficiency Under Load

The efficiency is defined as the ratio between the output power and input power.

3.2 Safety and Environmental Conditions

Sec	Parameter	Key	Min	Typ.	Max	Unit	Test Cond.
	Dielectric Strength		4,24			KV _{DC}	
	Operating Temperature		-5		40	°C	
			23		104	°F	
	Storage Temperature		-30	25	80	°C	
			-22	77	176	°F	
	Humidity				95	%	

	PRODUCT SPECIFICATION C2xFMW3 24W			Page 5/18	
	Document prepared and responsible for				
	M. Mauritz				
	Responsible for technical data		Day	Month	Year
S. Trethan		28	03	22	M

3.3 Output Specification

Parameter	Key	Min	Typ.	Max	Unit	Test Cond.	On request
Output Voltage	U_2	3		25,5	V	0 – 2,5 A	
Output Voltage Tolerance	T_{U_2}			1	%	at PCB for Li-ion	
Output Current	$I_{2\text{ Nominal}}$			2,5	A		3 A
Output Power	P_2		23,3		W		
Ripple Voltage	$U_{2,rms}$			80 100	mV _{rms}	$U_{IN} = 264V$ $U_{IN} = 90V$ Accu Load	

The unit is long time short circuit proof.

3.3.1 Maximal Power Ratings for NiMH/NiCd cells

Number of NiMH/NiCd cells	Nominal Battery Voltage [V]	Max. Output Voltage [V] (1,85V/cell)	Max. Output Current [A]
3	3,6	5,6	2,5 (3,0)
4	4,8	7,4	2,5 (3,0)
5	6,0	9,3	2,5
6	7,2	11,1	2,1
7	8,4	13	1,8
8	9,6	14,8	1,6
9	10,8	16,7	1,4
10	12	18,5	1,2
11	13,2	20,4	1,1
12	14,4	22,2	1,0
13	15,6	24,1	0,9
14	16,8	25,5 (1,82 V/cell)	0,9

	PRODUCT SPECIFICATION C2xFMW3 24W			Page 6/18
	Document prepared and responsible for			
	M. Mauritz			
	Responsible for technical data	Day	Month	Year
S. Trethan	28	03	22	M

3.3.2 Maximal Power Ratings for Li-ion cells

Number of Li-ion cells	Nominal Battery Voltage [V]	Max. Output Voltage [V]	Max. Output Current [A]
1	3,7	4,2	2,5 (3,0)
2	7,4	8,4	2,5
3	11,1	12,6	1,8
4	14,8	16,8	1,4
5	18,5	21,0	1,1
6	22,2	25,2	0,9

3.3.3 Reverse Current

Battery Voltage [V]	3	10	25
Reverse Current [mA]	0,1	0,2	0,5

3.3.4 Thermistor in battery (optional)

Typical NTC: $10K\Omega \pm 5\%$ @25°C, $\beta_{25-85^\circ C} = 3477$, referenced to battery negative.

3.3.5 Modes of Operation

RESET – BATTERY AND NTC DETECTION

Battery cells are switched off, no signaling, μP measures if battery voltage and optionally battery thermistor are available.

POLLING

The battery is shorted, empty or intrinsically safe and thus the measured voltage is low, no signaling, charger is switched on for 1ms/1sec, μP measures if some charge current flows => There is a battery at disposal

PRECHARGE I

Battery is connected, but its voltage is very low, customer specified signaling, defined Time Out, charger applies pulses to the battery => average charge current of 12mA, when battery voltage exceeds 3V, mode "Precharge II" begins.

PRECHARGE II

Battery voltage is in range from 3V up to (1V/cell x No. Of cells for Ni, 3V x No. Of cells for Li), customer specified signaling, defined Time Out, customer specified charge current

CHARGE PENDING

	PRODUCT SPECIFICATION C2xFMW3 24W			Page 7/18
	Document prepared and responsible for			
	M. Mauritz			
	Responsible for technical data	Day	Month	Year
S. Trethan	28	03	22	M

Battery temperature is either very low (typical below 0°C) or very high (typical over 40°C), customer specified signaling, defined Time Out, charger is switched off.

RAPID CHARGE

Battery is charged with maximum charge current (typical C/2), customer specified signaling.

Primary terminations for NiMH/NiCd: Temperature gradient dT/dt
 Drop Voltage –DV

Primary termination for Li-ion: I/10 - charge current falls below defined level

Default terminations: Maximum Cell Temperature
 Maximum Cell Voltage
 Time Out

TOP OFF CHARGE

NiMH/NiCd:

Pulsed charge using user defined current and 30% duty cycle with a period of 1 second. Top Off Charge ends after Time Out, Maintenance Charge begins. Customer specified signaling.

Li-ion:

Signaling shows “I am fully charged”, but the battery is still charged for defined time with a very low current

MAINTENANCE CHARGE

This is a low duty cycle current pulse applied after Top Off Charge to offset self discharge. The peak amplitude is the toff charge rate, pulse width is 1 s and the period is 60 seconds. Maintenance Charge ends after Time Out. Charger may restart if battery is simultaneously discharged and its voltage sinks below a defined level. Customer specified signaling.

Li-ion: This mode is skipped

CHARGE OVER

Charger is switched off, it may restart if the battery is simultaneously discharged and its voltage sinks under defined level. Customer specified signaling.

FAULT I

Charger is switched off because of high battery temperature, expired Time Out or short circuit during Rapid Charge. Unplug the battery to restart. Customer specified signaling.

FAULT II

Charger is switched off because of high battery voltage. Charger must be unplugged from mains to restart. Customer specified signaling.

	PRODUCT SPECIFICATION C2xFMW3 24W			Page 8/18
	Document prepared and responsible for			
	M. Mauritz			
	Responsible for technical data	Day	Month	Year
S. Trethan	28	03	22	M

3.3.6 Signaling

There is a single LED indicator with red/green LED in the charger. The two colours can be mixed to produce amber light, and various flashing light patterns are also available.

3.3.6.1 Examples of typical patterns used

Standard

Condition	LED Color
Rapid Charge	AMBER
Charge Complete	GREEN
Precharge	FLASHING AMBER
Charge Pending	FLASHING RED
Charge Failure	RED
No AC/Standby	OFF

Medical

Condition	LED Color
Rapid Charge	GREEN 50/50
Charge Complete	GREEN
Precharge	GREEN 10/90
Charge Pending	GREEN 10/90
Charge Failure	RED
No AC/Standby	OFF

3.3.6.2 Selection of standard LED patterns

Visible Colour	Green LED	Red LED
Dark	OFF	OFF
Green	ON	OFF
Red	OFF	ON
Amber	ON	ON
Flashing Red	OFF	0,5 sec ON / 1 sec (50/50)
Flashing Amber	0,25 sec ON / 1 sec (25/75)	0,25 sec ON / 1 sec (25/75)
Flashing Green	0,5 sec ON / 1 sec (50/50)	OFF
Fast Flashing Green	0,05 sec ON / 0,5 sec (5/45)	OFF
Flashing Green, low duty cycle	0,1 sec ON / 1 sec (10/90)	OFF

It is possible to create other patterns as required.

	PRODUCT SPECIFICATION C2xFMW3 24W			Page 9/18
	Document prepared and responsible for			
	M. Mauritz			
	Responsible for technical data	Day	Month	Year
S. Trethan	28	03	22	M

Schematical Example for cycle time:

Example for: 0,05 sec ON / 0,5 sec (5/45)

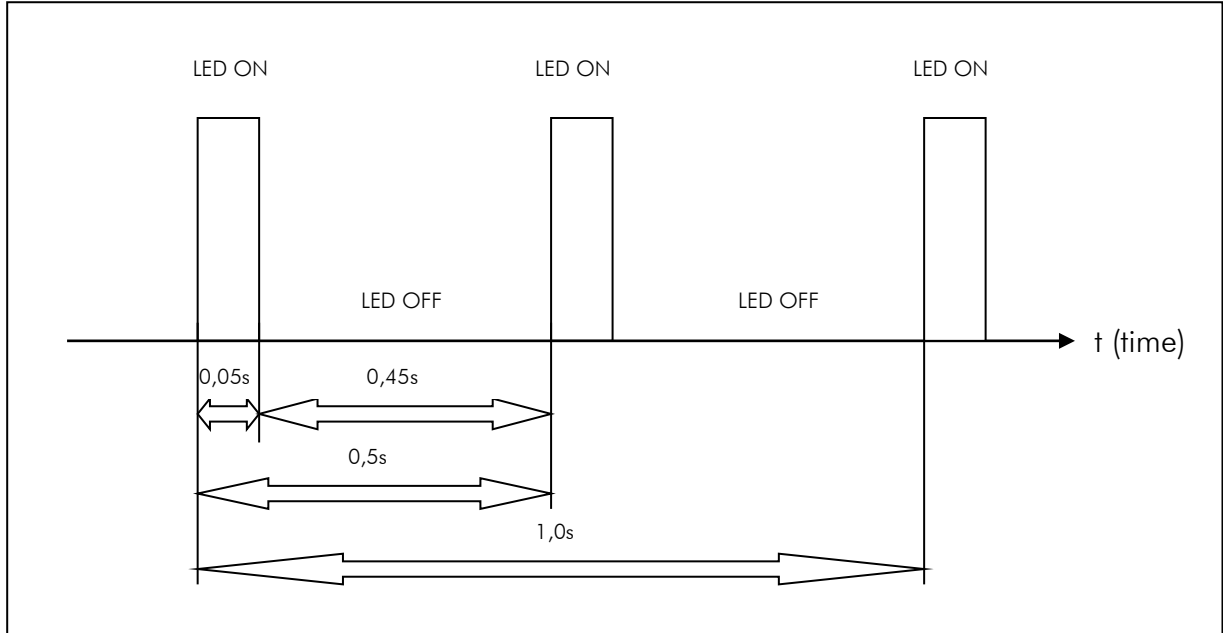

There are two types of LED lens available, the standard lens and the high diffusion lens. It is recommended to order the high diffusion lens for products using amber light to optimise light mixing and achieve a pleasing appearance.

	PRODUCT SPECIFICATION C2xFMW3 24W			Page 10 /18
	Document prepared and responsible for			
	M. Mauritz			
	Responsible for technical data	Day	Month	Year
S. Trethan	28	03	22	M

3.3.7 Special Features

Remote Voltage Sensing

Remote Voltage Sensing improves the battery voltage measurement precision, especially for intrinsically safe batteries or any other battery with diodes in series with a battery cell.

Output fuse

It is possible to add an output fuse (SMD case 1206) in the charger. It is not replaceable and insures increased safety.

Remote LED

Remote LED serves for remote signalling of the charge status. When the charger is hidden to the customer during charge, "Remote LED" lead is connected to Anode of an external LED, built for example into the battery pack. Signalling of this LED is customer defined.

Output current of 3A

This option is available on request for 3 or 4 NiMH / NiCd cells or 1 Li-ion cell. A special temperature conducting filler must be added between case and main board.

Auxiliary Power

It is possible to supply an unregulated voltage for some low energy device connected to the charged battery. This voltage varies, it is maximum (Open Voltage) when battery is switched off (because of high or low temperature or when full), its minimum value depends on the battery voltage when charger is switched on.

Customer specific secondary Plug

Document prepared and responsible for

M. Mauritz

Responsible for technical data

S. Trethan

Day

28

Month

03

Year

22

Revision

M

3.4 Mechanical Parameters

3.4.1 Housing dimension

3.4.1.1 Euro housing

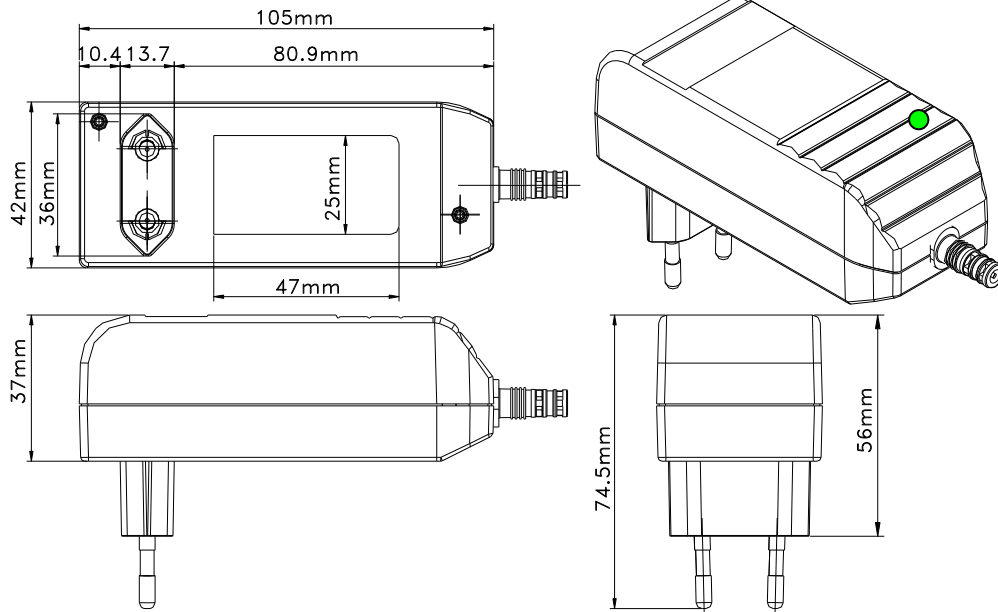

Document prepared and responsible for

M. Mauritz

Responsible for technical data

S. Trethan

Day

28

Month

03

Year

22

Revision

M

3.4.1.2 US Housing

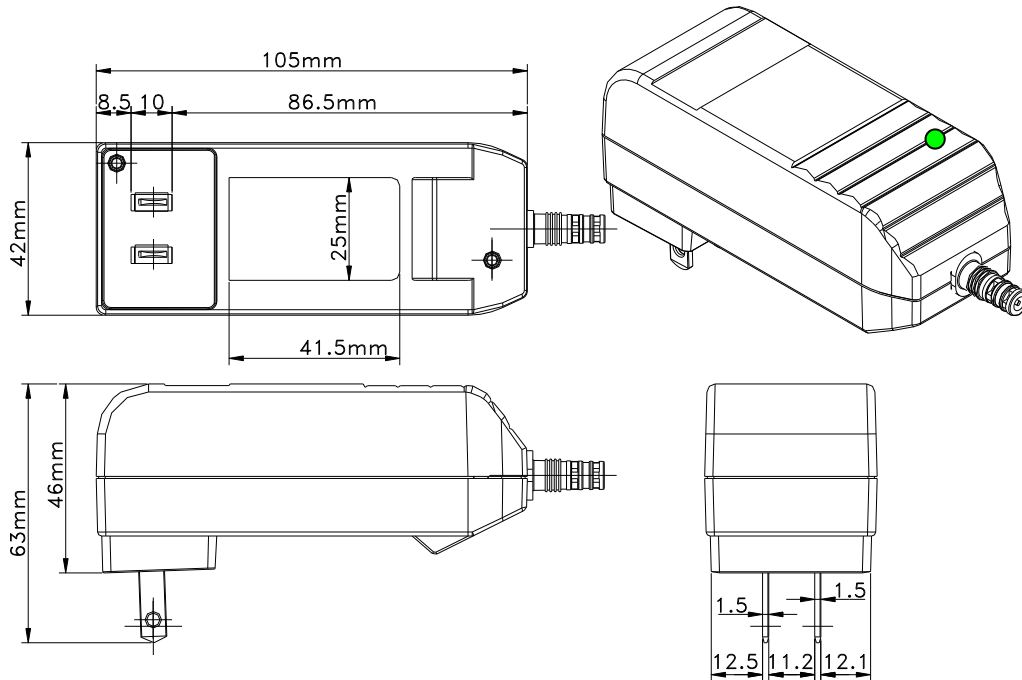

3.4.1.3 UK Housing

3.4.1.4

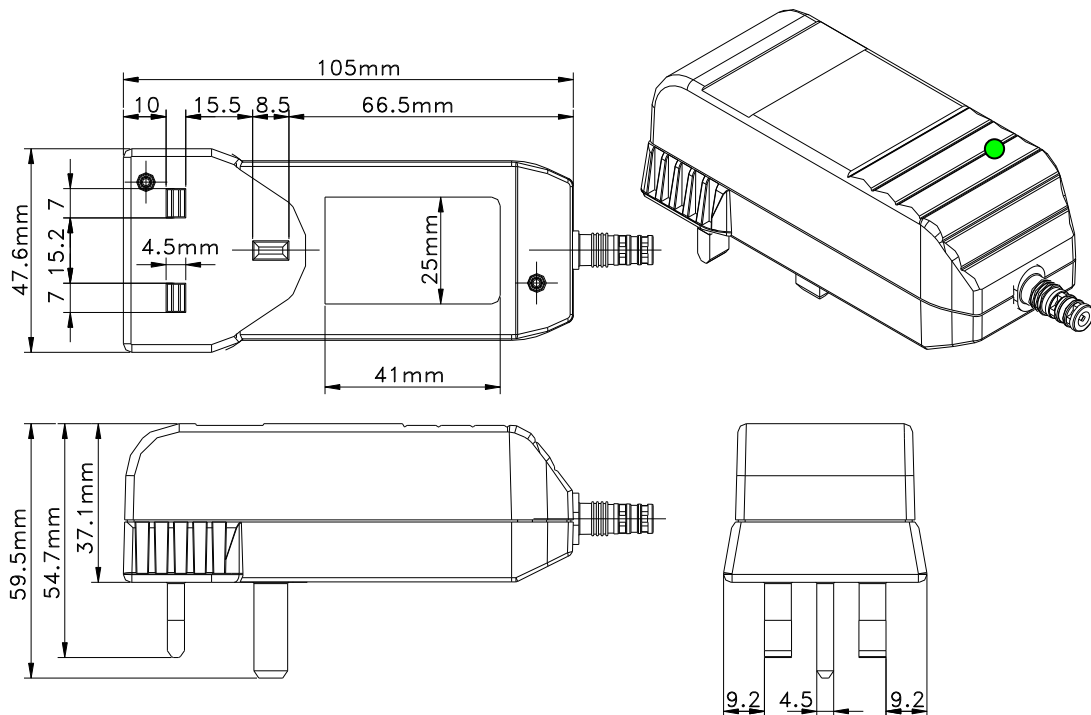

Document prepared and responsible for

M. Mauritz

Responsible for technical data

S. Trethan

Day

28

Month

03

Year

22

Revision

M

Desk Top Housing

With IEC 320 C14 Primary Plug

With IEC 320 C8 primary Plug

(Medical device only IEC 320 C8 or C18)

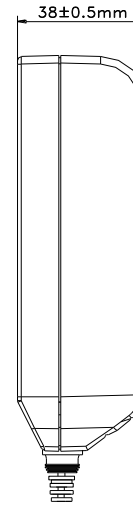
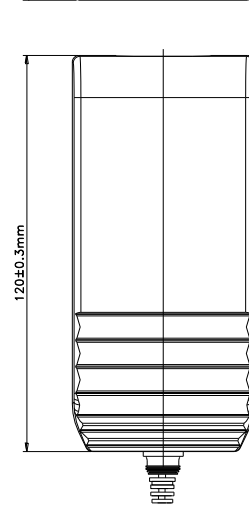
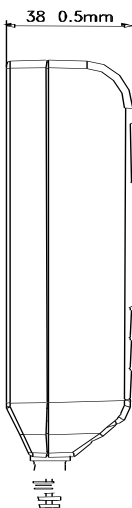
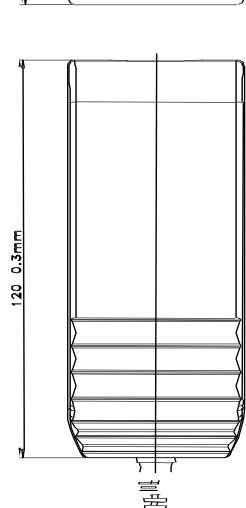
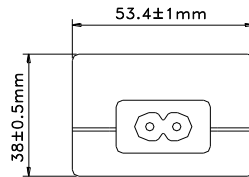
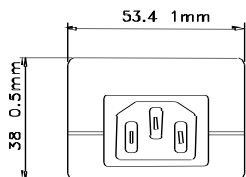

Document prepared and responsible for

M. Mauritz

Responsible for technical data

S. Trethan

Day

28

Month

03

Year

22

Revision

M

3.4.1.5 Changeable Plug Housing

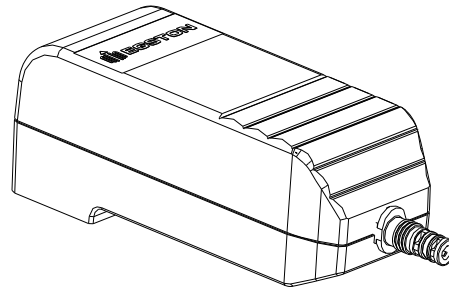
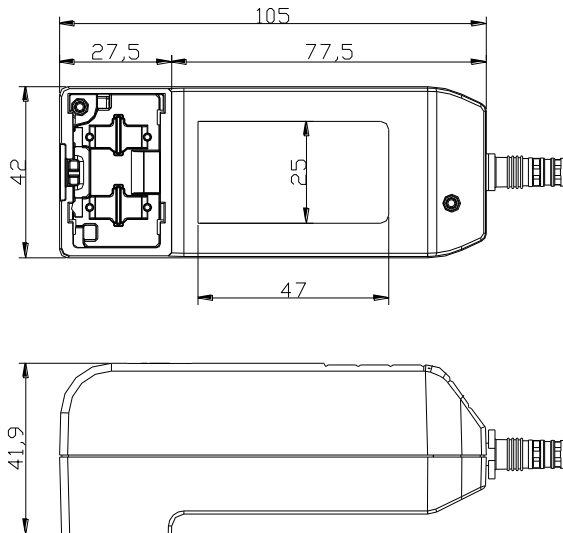

**EU Plug according:
EN50075**

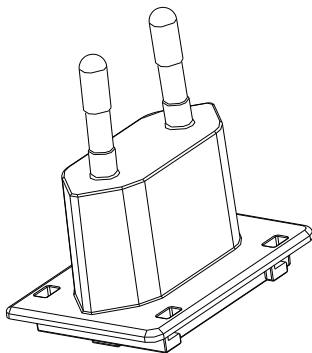

**UK Plug according:
BS1363**

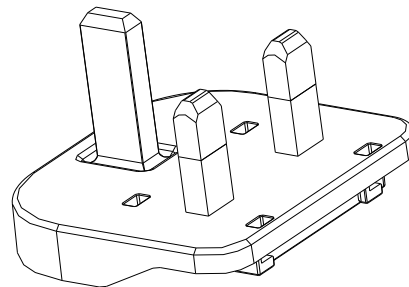

**US Plug according:
UL1310**

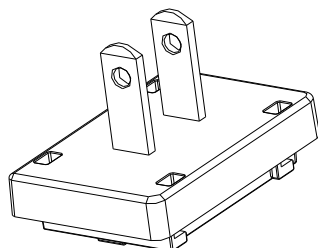

**Australia Plug according:
AS/NZS 3112**

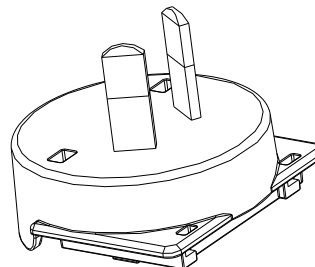

	PRODUCT SPECIFICATION C2xFMW3 24W			Page 15 /18	
	Document prepared and responsible for				
	M. Mauritz				
	Responsible for technical data		Day	Month	Year
S. Trethan		28	03	22	M

3.4.2 Housing Material

	12W UK,EURO,US	24W UK,EURO,US	DESKTOP
Material	PA6,V0	PA6,V0	PA6,V0
Flammability rate	V0	V0	V0

3.5 Cable and Connector

According to customer's requirements.

Minimum two leads:

Charger Negative Output (e.g. white)

Charger Positive Output (e.g. red)

Optionally:

Thermistor (e.g. green)

Positive Voltage Sense (e.g. yellow)

Remote LED Output or Auxiliary Power (e.g. blue)

	PRODUCT SPECIFICATION C2xFMW3 24W			Page 16 /18	
	Document prepared and responsible for				
	M. Mauritz				
	Responsible for technical data		Day	Month	Year
S. Trethan		28	03	22	M

4 ORDERING INFORMATION

4.1 SMPS

	POWER CLASS	24 Watt
C	SUPPLY TYPE	C = Charger Generation
2	OPERATION TEMP. RANGE	2 = -5°C to +40°C
E	PRIMARY CONNECTOR	E = Euro plug U = US/Japan/Canada Plug G = United Kingdom Plug D = Desktop Module C = Changeable Plug
F	CABLE CONNECTION	F = Fixed
S	APPLICATION	M = Medical
W	WIDE INPUT RANGE	W = 90V-264V
24W	HOUSING DIMENSION	24W
12V	OUTPUT VOLTAGE	3.0V-25,5V
2A	OUTPUT CURRENT	2500mA max.

	PRODUCT SPECIFICATION C2xFMW3 24W			Page 17 /18
	Document prepared and responsible for			
	M. Mauritz			
	Responsible for technical data	Day	Month	Year
S. Trethan	28	03	22	M

4.2 Charger

For setting of charge parameters we need the following information:

1/ Type of the battery

(Li-ion, NiMH, NiCd, other)

2/ Datasheet of the battery

(battery capacity, maximum charge current, maximum temperature during charge, charge curves at various ambient temperatures, manufacturer)

3/ Configuration of the battery Pack

(number of cells in series, parallel, NTC specification – when used, define “Special features” – see 3.3.7, elements in series with the battery cell, parallel discharge operation)

4/ Signaling

(e.g. A8/B6/C5/D2/E7, see 3.3.6)

5/ Required standards

6/ Marking

7/ Definition of the output cord (number of leads, length)

+ nominal length 2m

8/ Definition of the output connector

+ standard connectors upon request

9/ Amount of required samples

	PRODUCT SPECIFICATION C2xFMW3 24W			Page 18 /18	
	Document prepared and responsible for				
	M. Mauritz				
	Responsible for technical data		Day	Month	Year
S. Trethan		28	03	22	M

5 PACKAGING AND WEIGHT

Cable with connector 5.5/2.1	38 G
Instruction Manual	3.6 G
Euro pallet empty (wooden):	21 Kg

SINGLE PACKAGING			PS 1.5m cable+connector 5.5/2.1								Single carton			Packing case			Euro pallet		
			Single carton empty		Single carton full		Packing case empty		Packing unit		Packing case full		Cartons per pallet		Euro pallet full				
P2	EU	24W	178	15	193	180	50	9.6	18	211	136x76x43.5		388x280x226		1200x800x				
P2	US	24W	178	15	193	180	50	9.6	18	194	136x76x43.5		388x280x226		1200x800x				
P2	Uk	24W	178	16	194	180	50	9.6	18	194	136x76x50.5		388x280x260.5		1200x800x				
Unit			g	g	g	g	Pcs.	kg	Pcs.	kg	mm		mm		mm				

6 STANDARDS

EN 55032 EN 55035 EN 60601-1-2	General EMC standards
EN 60601-1* UL 60601-1	Medical electrical equipment

	PRODUCT SPECIFICATION C2xFMW3 24W			Page 19 /18
	Document prepared and responsible for			
	M. Mauritz			
	Responsible for technical data	Day	Month	Year
S. Trethan	28	03	22	M

7 APPROVALS



C/US NRTL recognized approval issued by UL



Conformity with the EU low voltage directive and EMC directive



Conformity with the relevant UK regulations.

EMC – Special requirements according medical standard	
Intended use and intended environment	Home healthcare and/or Professional environment
Basic safety and essential performance of the EUT	The power supply unit is not a medical end product, therefore no essential performance is defined by the manufacturer.
Basic safety regarding EMC	The power supply has to ensure proper output voltage according to its characteristics, without service within expected service life.
WARNINGS	Medical electrical equipment needs special precautions regarding EMC and needs to be installed according to EMC information. PE of power supply shall be connected to PE of end medical product. User shall not modify power supply.
	The switch mode power supply is designed to achieve the EMI behavior of the specified environment, it includes specific EMI filter to reduce the emissions which are specified in the IEC60601-1-2 standard.
	Please read the complete technical documentation to avoid adverse events to the patient and operator. Read also instructions for use.

	PRODUCT SPECIFICATION C2xFMW3 24W			Page 20 /18	
	Document prepared and responsible for				
	M. Mauritz				
	Responsible for technical data		Day	Month	Year
S. Trethan		28	03	22	M

EMC - Environment			
The power supply is intended for use in the electromagnetic environment specified below. The customer or the user of the power supply should assure that it is used in such an environment.			
Emissions test	Compliance	Electromagnetic environment - guidance	
RF emissions CISPR 11	Group 1	The power supply uses RF energy only for its internal function. Therefore, its RF emissions are very low and are not likely to cause any interference in nearby electronic equipment.	
RF emissions CISPR 11	Class B	The power supply is suitable for use in all establishments, including domestic establishments and those directly connected to the public low-voltage power supply network that supplies buildings used for domestic purposes.	
Harmonic emissions IEC 61000-3-2	Complies		
Voltage fluctuations / flicker emissions IEC 61000-3-3	Complies		
Immunity test	EN 60601-1-2:2015 test level	Achieved levels according EN 60601-1-2:2015 and achieved levels from additional standards.	Electromagnetic environment - guidance
Electrostatic discharge (ESD) IEC 61000-4-2	± 8 kV contact ±2 kV, ± 4 kV, ± 8 kV, ± 15 kVair	± 8 kV contact ±2 kV, ± 4 kV, ± 8 kV, ± 15 kVair	Floors should be wood, concrete or ceramic tile. If floors are covered with synthetic material, the relative humidity should be at least 30%.
Electrical fast transient/burst IEC 61000-4-4	± 2 kV 100 kHz repetition frequency	± 2 kV (mains input), 100 kHz ± 2 kV (DC output), 5 kHz	Mains power quality should be that of a typical commercial or hospital environment.
Surge IEC 61000-4-5	Line-Line:± 0,5 kV, ± 1 kV	Line-Line:± 0,5 kV, ± 1 kV	Mains power quality should be that of a typical commercial or hospital environment.
Voltage dips, short interruptions and voltage variations on power supply input lines IEC 61000-4-11	0 % Ut; 0,5 cycle At 0°, 45°, 90°, 135°, 180°, 225°, 270° and 315° 0 % Ut; 1 cycle and 70 % Ut; 25/30 cycles Single phase: at 0° 0 % Ut; 250/300 cycle	0 % Ut; 0,5 cycle At 0°, 45°, 90°, 135°, 180°, 225°, 270° and 315° 0 % Ut; 1 cycle and 70 % Ut; 25/30 cycles Single phase: at 0° 0 % Ut; 250/300 cycle	Mains power quality should be that of a typical commercial or hospital environment. If the user of the power supply requires continued operation during power mains interruptions, it is recommended that the power supply is powered from an uninterruptible power supply or battery.
Power frequency (50/60 Hz) magnetic field	30 A/m	1, 3, 30 A/m	Power should be at levels characteristic of frequency magnetic fields a typical location in a typical commercial or hospital environment.

	PRODUCT SPECIFICATION C2xFMW3 24W			Page 21 /18	
	Document prepared and responsible for				
	M. Mauritz				
	Responsible for technical data		Day	Month	Year
S. Trethan		28	03	22	M

IEC 61000-4-8			
Conducted RF IEC 61000-4-6	6 Vrms 150 kHz to 80 MHz	6 Vrms	Portable and mobile RF communications equipment should not be used closer to any part of the power supply, including cables, than the recommended separation distance.
Radiated RF IEC 61000-4-3	10 V/m 80 MHz to 2.7 GHz	10 V/m	Recommended separation distances see following table.

Field strengths from fixed transmitters such as base stations for radio (cellular/cordless) telephones, land mobile radios, amateur radio, AM and FM radio broadcast and TV broadcast, cannot be predicted theoretically with accuracy. To assess the electromagnetic environment due to fixed RF transmitters an electromagnetic site survey should be considered. If the measured field strength in the location in which the power supply is used, exceeds the applicable RF compliance level above, the power supply should be observed to verify normal operation. If abnormal performance is observed, additional measures may be necessary, such as reorienting or relocating the power supply.

Field strengths from fixed RF transmitters, as determined by an electromagnetic site survey should be less than the compliance level in each frequency range. Over the frequency range 150 kHz to 80 MHz, field strength should be less than 3 V/m.

Interference may occur in the vicinity of equipment marked with the following symbol: 

Proximity fields from RF wireless communications equipment IEC 61000-4-3	Frequency range and Level: RF wireless communication equipment			Supplementary information: EUT powered at one of the nominal input voltages and frequencies. Dwell time minimum 1s. Actual dwell time noted in results table. Note * - As an alternative to FM modulation, 50% pulse modulation at 18Hz may be used because while it does not represent actual modulation, it would be worst case. Note ** - The carrier shall be modulated using 50% duty cycle square wave signal.
	Test Frequency (MHz)	Modulation	Immunity Level (V/m)	
	385	**Pulse Modulation: 18Hz	27	
	450	*FM ±5Hz deviation: 1kHz sine	28	
	710 745 780	**Pulse Modulation: 217Hz	9	
	810 870 930	**Pulse Modulation: 18Hz	28	
	1720 1845 1970	**Pulse Modulation: 217Hz	28	
	2450	**Pulse Modulation: 217Hz	28	
	5240 5500 5785	**Pulse Modulation: 217Hz	9	

Recommended separation distances between portable and mobile RF communications equipment and the power supply

The power supply is intended for use in the electromagnetic environment in which radiated RF disturbances are controlled. The customer or the user of the power supply can help prevent electromagnetic interference by maintaining a minimum distance between portable and mobile RF communications equipment (transmitters) and the power supply as recommended below, according to the maximum output power of the communication equipment.

Rated maximum output power of transmitter (W)	Separation distance according to frequency of transmitter (m)		
	150 kHz to 80 MHz $d = 1.2\sqrt{P}$	80 MHz to 800 MHz $d = 1.2\sqrt{P}$	800 MHz to 2.5 GHz $d = 2.3\sqrt{P}$
0.01	0.12	0.12	0.23
0.1	0.38	0.38	0.73
1	1.2	1.2	2.3
10	3.8	3.8	7.3
100	12	12	23

	PRODUCT SPECIFICATION C2xFMW3 24W			Page 22 /18	
	Document prepared and responsible for				
	M. Mauritz				
	Responsible for technical data		Day	Month	Year
S. Trethan		28	03	22	M

For transmitters rated at a maximum output power not listed above, the recommended separation distance d in metres (m) can be determined using the equation applicable to the frequency of the transmitter, where P is the maximum output power rating of the transmitter in watts (W) according to the transmitter manufacturer.

- NOTE 1 At 80 MHz and 800 MHz, the separation distance for the higher frequency range applies.
 NOTE 4 These guidelines may not apply in all situations. Electromagnetic propagation is affected by absorption and reflection from structures, objects and people.